

DETAIL B

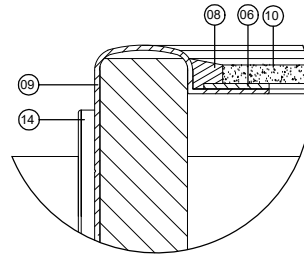

DETAIL H

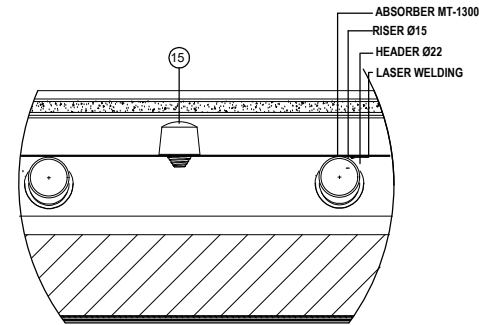

DETAIL G

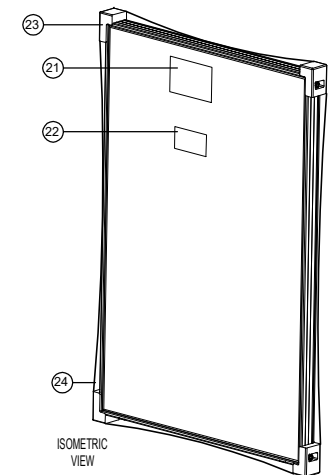

ISOMETRIC VIEW

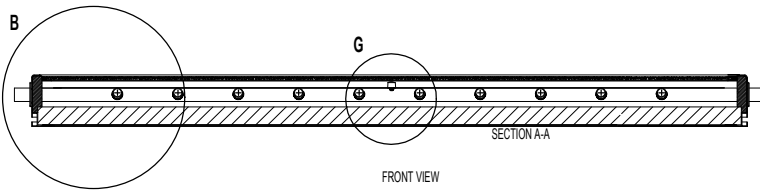

FRONT VIEW

1183 ALUMINIUM FRAME (GROSS)
1135 GLASS
1119 (APERTURE)
1085 ABSORBER SHEET BLUE SELECTIVE

SIDE VIEW

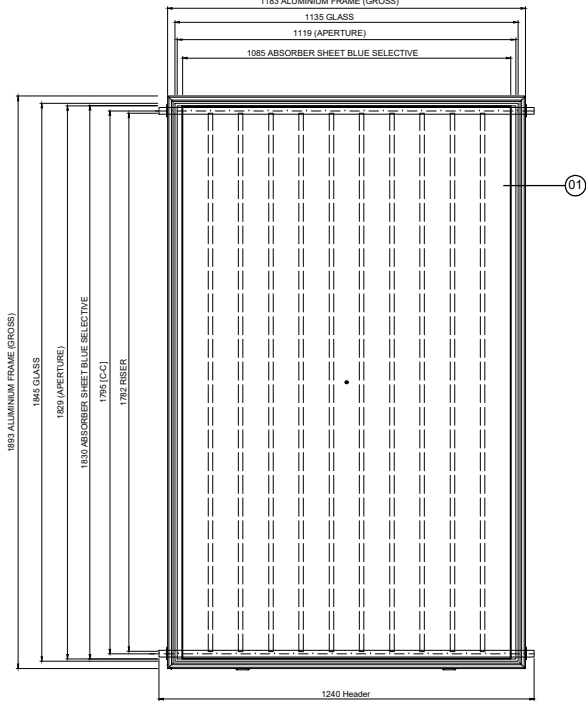

1893 ALUMINIUM FRAME (GROSS)

184 GLASS

1820 (APERTURE)

1830 ABSORBER SHEET BLUE SELECTIVE

1794 (C/C)

1782 RISER

1240 Header

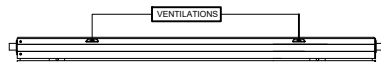

VENTILATIONS

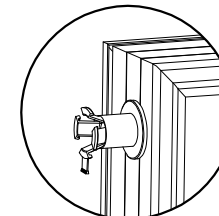
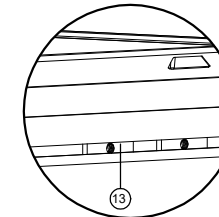
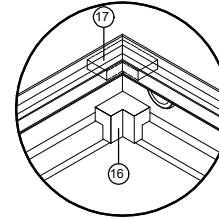
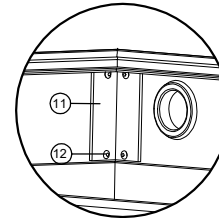

24	PRODUCT'S PACKAGING FILM WRAP	103209	188
23	COLLECTOR'S PACKAGING CORNER PROTECTION	103749	297
22	PRODUCT'S PACKAGING LABEL	107318	0
21	PRODUCT'S WARNINGS SIGN	107301	0
20	UP SIGN	107319	0
19	PRODUCT'S LABEL	107321	0
18	BACK PLATE-PROFILE FRAME DURABILITY SUPPORT BEAM	107377	550
17	ALL UPPER CORNERS PROFILE FRAME'S SUPPORT SEALANT	107287	306
16	BOTTOM CORNER-UPPER SIDE PROFILE FRAME'S SUPPORT SEALANT	107288	307
15	ABSORBER-GLASS SPACER	106307	237
14	HEADER-FRAME GASKET	100496	12
13	PROFILE'S FRAME MOVEABLE FIXING NUTS	102745	0
12	PROFILE'S FRAME EDGE BLIND RIVET CONNECTOR	103829	301
11	PROFILE'S FRAME EDGE ANGLE BAR CONNECTOR	100277	0
10	COLLECTOR'S TRANSPARENT COVER	102424	121
09	COLLECTOR'S PROFILE FRAME	102509	202
08	GLASS-FRAME SEALANT	100811	291
07	BACK PLATE INSULATION COVER	102177	299
06	GLASS-PROFILE FRAME HOLDER TAPE	104543	287
05	BACK PLATE-PROFILE FRAME HOLDER TAPE	105604	286
04	PROFILE'S FRAME LATERAL INSULATION	107973	0
03	BACK PLATE INSULATION	102810	135
02	BACK PLATE	105681	285
01	ABSORBER	108305	0

N/N	GROUP	CONSUMED ITEM CODE	DVCD
Gross Weight (kg):		General Tolerance: ±1mm	
Units:	Scale:	Item Code:	DVCD:
MM	1:10	108317	0
Creator:		N/N SH (Revision):	Date of Issue:
		1258	15/05/2020
		Item Description:	
		Plan_108317_FOXAL23V_2020	
		DVCD Description:	
		#	